

# ISIC

Solutions in Metal



# ZIPLINE RANGE

## Performance & Longevity

Bearings are a critical component for performance and longevity, so our **Zip Trolleys** utilise only the highest quality twin bearings, sourced directly from specialist bearing manufacturers.

All ISC **Trolley** bearings are fitted with rubber seals. These seals reduce corrosion and help to defend the bearing from the ingress of dirt, debris and moisture. The presence of this specific seal means that the actual bearing does not need to be maintained or re-greased.

The **bearing housing** (the wheel), is also a vital component for performance and longevity. Our **wheels** are made from a superior grade Stainless Steel, which is machined and then heat treated in house to increase its hardness. This manufacturing process allows the **wheels** to resist deformation and to provide optimal support to the bearing, without causing any detrimental effect to the cable surface.

## Safety

For maximum user safety, all of our **Zip Trolleys** have load rated primary connection points, as well as the option to fit/mount a secondary safety lanyard attachment which captivates the zip line. All ISC **Trolleys** are fitted with tamper-proof axle rivets.

## Maximising Throughput

We know that during busy periods, it's important for operators to get their visitors down the lines as efficiently as possible. Rescue of riders who come to a halt near to the end of the line and then roll backwards (often all the way into the middle of the line), can have a serious effect on throughput and can cause delays/late finishes, customer frustration – and loss of revenue! All of our **Zip Trolleys** are available with factory or retro fit 'ARC' (Anti-Rollback Cams) devices, to alleviate this problem.

## Braking System Compatibility

All ISC **Trolleys** are suitable for use with the vast majority of line-mounted braking systems. Our latest models are fitted with new, improved **end stops**. The new **end-stop** design provides improved compatibility with brake shuttles and offers superior impact protection to the **trolley** side plates. We also offer a 'Grab-catch' hook accessory, which allows trolleys full compatibility with 'Grab-catch' hoop systems, allowing the hoop on the brake shuttle to captivate the hook on the **trolley**. This captivation means that the end of line braking system cannot propel users backwards down the line, as it resets its position.

## User Experience

We have a wide range of **accessories**, aimed at offering a range of different user experiences. Whether your **Zip Line** is designed to offer maximum user engagement, an optimal sight-seeing or high adrenaline experience, there's an **accessory** to suit!



\*Cover Photo (Right Image) Courtesy of NON-LIMITS, Mexico

# ZIPLINE TROLLEYS

The compact **Zippey Trolley** has been introduced to compete with lightweight one-handed fitting trolleys. Often the trolleys for this end of the market are 'low-cost' or 'budget' options, which suffer the common problems of premature wear (due to poor materials), short bearing life (due to poor quality bearings) and offer very few features.

The **Zippey** is a compact, lightweight **Trolley** for up to 13mm (1/2") diameter cable. The **Zippey** is ideally suited for use on short to medium length lines. The **Zippey** can easily be stored on the user's harness and carried when walking to and between ziplines. **Zippey** is fitted with a spring-loaded **Double Action** gate, which can be operated (and the **Trolley** mounted on the zipwire), quickly and easily in a **one-handed operation**. The **Zippey** can be used with a direct lanyard connection, or with a lanyard connected with a Karabiner. **Hooked** end stops are available and can be used to mount a secondary lanyard to the **Trolley**.

**ZipSpeed Trolleys** are fitted with special Rubber-sealed, Deep Groove Ball Bearings as standard. These bearings have been chosen for optimal high speed, low friction performance. The rubber seals retain the grease lubricant, whilst defending the bearings from moisture and contaminants; giving the **ZipSpeed** a lifespan of thousands of miles/kilometres.

The **ZipSpeed-S Trolley** is an intermediate **Trolley**, with models available for 13, 16 or 20mm (1/2, 5/8 or 3/4") diameter cables. The S-model is suited to medium length, medium speed ziplines. The **ZipSpeed-S** has three main attachment points and a rear attachment point which allows the operator to attach a secondary lanyard, with a connector which captivates the zipcable.

The **ZipSpeed-L** is the ideal **Trolley** for medium length or longer, faster lines! **ZipSpeed-L** versions are available for cable diameters of 13, 16 or 20mm (1/2, 5/8 or 3/4"). **ZipSpeed-L** is compatible with the Superman and Parachute style harnesses. (Stabiliser bar accessory is also required in order to use the Parachute Harness.)

## ZipSpeed Colour Size Indicator Sleeve

-  13mm (1/2") Wire
-  16mm (5/8") Wire
-  20mm (3/4") Wire



**RP074 Zippey Trolley**

**Weight** 450g (1lb)

**MBS** 25kN (5620lbf)

**Max. Cable** 13mm (1/2")

**Wheel Material** Stainless Steel

**Wheel Diameter** 29mm (1 3/16)

Available with choice of hooked or flat end-stops.



**RP075 Zipspeed-S Trolley**

**MBS** 40kN (8992lbf)

**Weight** 875g (31oz)

**Wheel Material** Stainless Steel

**Wheel Diameter** 50mm (2")

Available Models

**RP075A** 13mm (1/2") Wire

**RP075B** 16mm (5/8") Wire

**RP075G** 20mm (3/4") Wire



**RP076 Zipspeed-L Trolley**

**MBS** 40kN (8992lbf)

**Weight** 1810g (64oz)

**Wheel Material** Stainless Steel

**Wheel Diameter** 75mm (3")

Available Models

**RP076A** 13mm (1/2") Wire

**RP076B** 16mm (5/8") Wire

**RP076G** 20mm (3/4") Wire

# ANTI-ROLLBACK CAM

The Anti-Rollback Cam is a simple device which can be retro-fitted to the ZipSpeed and Zippey Trolleys. During normal use, the cam trails, allowing the trolley to roll forwards, unhindered. However, as soon as the trolley begins to roll backwards, the cam is activated, bringing the trolley to an immediate halt. This anti-rollback function captures the progress of the trolley, which means that even when the trolley doesn't reach the end of the zipline, it cannot roll backward and hence rescue distance (and therefore, rescue time) is significantly reduced.

Some trolleys are fitted with one-way bearings which are supposed to stop the trolley from rolling backwards but tests and feedback have shown the ARCs to be a much more effective and inexpensive solution.

The Anti-rollback Cam (ARC) is great for use with braking systems! As soon as the braking system has completed its function in slowing and subsequently stopping the forward movement of the trolley, the trolley can often begin to roll backwards! If not caught by a member of staff (who may have multiple lines to supervise), the rider can soon-after find themselves stranded mid-way down the zipline. The ARC alleviates this problem!



**ARC074 Zippey ARC Cam**  
**Weight** 59g (2oz)  
**Max. Cable** 12mm - 13mm (1/2")  
**Versions Available** 12mm & 13mm

Part Code	Compatible with	Cable Diameter Options
ARC074A1	RP074 Zippey (all versions)	12mm
ARC074A2	RP074 Zippey (all versions)	13mm
ARC075A1	RP075 ZipSpeed Trolley	13mm
ARC075A2	RP075 ZipSpeed Trolley	12mm
ARC075B1	RP075 ZipSpeed Trolley	16mm
ARC076A1	RP076 ZipSpeed Trolley	13mm
ARC076A2	RP076 ZipSpeed Trolley	12mm
ARC076B1	RP076 ZipSpeed Trolley	16mm
ARC076G1	RP076 ZipSpeed Trolley	20mm
ARC076G2	RP076 ZipSpeed Trolley	19mm
ARC076G3	RP076 ZipSpeed Trolley	18mm

**Cam in Neutral 'Trailing' Position**

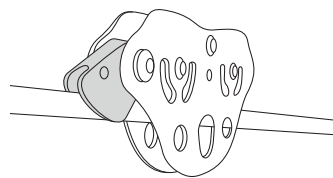

**Cam Activated on Line**

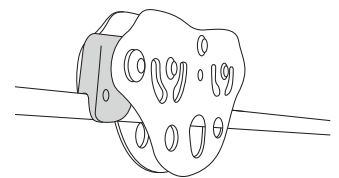

**ARC075/6 ZipSpeed ARC Cam**

**Weight** 69g - 100g (2oz)  
**Max. Cable** 12mm - 20mm (1/2" - 3/4")  
**Versions Available** 12mm, 13mm, 16mm, 18mm, 19mm, 20mm

## Correct Measurement of Cable

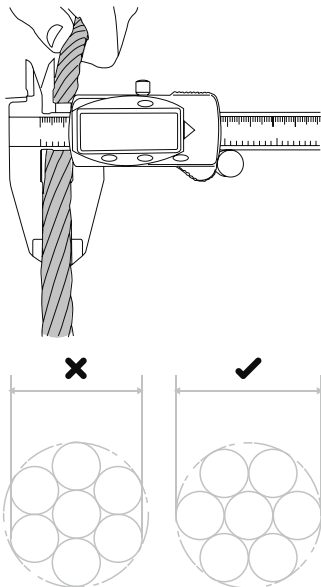

**IMPORTANT** - Smooth cable (swaged or interlocked) improves the performance of the trolleys and ARCs. Conversely, coarse-lay cables reduce the lifespan of the trolleys and ARCs.

We can also supply the ARCs fully fitted and assembled with the Trolley, please contact us for more information.

**IMPORTANT** - Due to the many different cable types and variables affecting usage we recommend that you carry out trial evaluations with a sample ARC on your chosen trolley and cable to ensure compatibility and suitability in the environment which you intend to use them. If your cable size is not listed please request a sample for evaluation.



# GRAB-CATCH

The 'Grab-catch' hook accessory allows our trolleys full compatibility with 'Grab-catch' hoop systems, allowing the hoop on the brake shuttle to captivate the hook on the trolley.

This captivation means that the end of line braking system cannot propel users backwards down the line, as it resets its position.

The Grab-catch hook can be easily retro-fitted to a Zip Trolley using standard tools.

**GRAB075 & GRAB076** ZipSpeed Grab-catch Available Soon

**GRAB074A1** Zippey Grab-catch

**Weight** 88g (3oz)

**Height** 63mm (2 1/2")

**Width** 75mm (3")

**Thickness** 6mm (1/4")



# SPECIALIST HARNESSSES

The **Parachute Harness** offers riders the opportunity to admire the view, from a secure seated position. This **harness** is available in five sizes (S—XXL) and can accommodate a maximum user weight of 150kg (310lbs). Each **harness** is supplied with 'W' attachment bridle, which can be ordered separately and replaced on site as required. The **Parachute Harness** is compatible with the RP076 **Large ZipSpeed Trolley**- fitted with **Stabiliser Bars**, which are available as factory-fitted, or a retro-fit accessory kit.

The **Superman Harness** offers the ultimate exhilarating 'flying' experience and is ideally suited to long, fast & high adrenaline lines! The **Superman harness** is mounted directly to the attachment holes of the RP076 **Large ZipSpeed Trolley**.

Both **harnesses** are worn as a suit and users are free to walk between zip lines, without having to remove the harness.

**5AB-ZLSEAT** Parachute Harness

**Weight** 3kg (6.6lb)

**Recommended Karabiners** 2x KL311TL & 1x KH212TL

**Sizes** S - XXL

(Upper-right)

**5AB-ZLH** Superman Harness

**Weight** 2kg (4.4lb)

**Recommended Karabiners** 3x KH212TL

**Sizes** S - XXL

(Lower-right)



# ZIPPEY HANDLE BAR

HAN074A1 features a central bollard, which accepts 25mm (1") rope/webbing lanyard or Karabiner connection, and is compatible with RP074 Zippey Clip'n'Zip Trolley



**HAN074** Zippey Handle Bar  
**Weight** 59g (2oz)  
 Compatible with Zippey Clip'n'Zip Trolley (see page 3)

## LANYARDS

We offer a wide range of **fixed-length** and **adjustable length** webbing and rope lanyards.

Rope lanyards are available with soft, or thimble eye loops. Webbing lanyards are supplied with standard soft eye-loops,

Other lengths are available.

### LAN-WA

**Material** Webbing (25mm)  
**Length** 600mm-800mm Adjustable  
**Eye Type** Soft Eye  
**Compatibility** Direct to HAN074

### LAN-RDS

**Material** LSK Rope (11mm)  
**Length** 300mm (11") Fixed  
**Eye Type** Soft Eye  
**Compatibility** Direct to HAN074



### SCM-LRA101

**Material** Webbing (25mm)  
**Length** 600mm-900mm Adjustable  
**Eye Type** Soft, Choke-hitch Eye  
**Compatibility** Direct to RP074 Trolley and RP430 Smartsnap

### LAN-RA

**Material** LSK Rope (11mm)  
**Length** 600mm-800mm Adjustable  
**Eye Type** Soft Eye  
**Compatibility** Direct to HAN074

### LAN-WS

**Material** Webbing (25mm)  
**Length** 300mm (11") Fixed  
**Eye Type** Soft Eye  
**Compatibility** Direct to HAN074

### LAN-RA

**Material** LSK Rope (11mm)  
**Length** 600mm-800mm Adjustable  
**Eye Type** Thimble Eye  
**Compatibility** Connects to Trolley or Handle Bar with Connector

### LAN-RS

**Material** LSK Rope (11mm)  
**Length** 600mm-800mm Fixed  
**Eye Type** Thimble Eye  
**Compatibility** Connects to Trolley or Handle Bar with Connector

### 5CM-LRA101 Adjustable Lanyard

**Length**  
**Minimum** 600mm (24")  
**Maximum** 900mm (35")

# LOW-NOISE ZIP TROLLEYS

Our project with ZipWorld tackled the issue of sound emission, with ZipWorld taking a pro-active approach to **reducing** the noise generated from its zip lines and considering the effect on local residents and wildlife.

Noise reducing systems play a pivotal role, when looking to grow the number of zip lines at any one location, as the more lines in operation, the more sound produced. We relished the challenge and set about the task of developing the means of making our ZipSpeed Trolleys run near silent, whilst maintaining the key design features which make it such a successful and integral part of Zipworld's offering.

We worked closely with ZipWorld to design and manufacture a trolley that was capable of performing at speeds of over **100mph**, whilst suspended 500ft in the air. The trolley had to be capable of repeating this feat over and over, as demand was expected to be high. Years since ZipWorld opened its doors at the Velocity ride in North Wales, it now operates at three Zipline sites. This is a reflection of its popularity and success and ZipWorld is now looking to erect more lines at its sites, in order to satisfy the demand.

Our new range of ZipSpeed Noise Reduction Trolleys are fitted with Nylon Wheels.

Wheels made from Nylon are commonly used in factory environments, due to their optimal balance of high **reliability** and **durability**, together with their ability to reduce machinery noise to an acceptable level.

Our Nylon wheels have shown a noise reduction of as much as **7dB**, when tested on a range of cable types.

Noise Reduction Wheels are available on our 13mm and 16mm (1/2" and 5/8") ZipSpeed models- (please add part code suffix 'NR' to our regular part codes).

Our Nylon wheels are suitable for use on all industry-standard Zipline cables, however for maximum performance and durability, we recommend the use of smooth-surfaced 'Interlocked' cable.

**RP076A1.2-NR 13mm** Noise Reduction Trolley

**Max. Rope Diameter** 13mm (1/2")

**Wheel Material** Nylon

**RP076B1.2-NR 16mm** Noise Reduction Trolley

**Max. Rope Diameter** 16mm (5/8")

**Wheel Material** Nylon



# ZIP WORLD

# ACCESSORY COMPATIBILITY

Anti-rollback Cams are trolley-specific. Upon ordering, please specify which ISC trolley model you intend to use the accessory with, so that we can ensure that we supply the correct ARC for your trolley. Additionally, Anti-rollback Cams are cable diameter specific. Please provide your cable diameter measurement together with details of the cable construction.

Grab-catch Hooks are trolley specific. Upon ordering, please specify the trolley model. If you are ordering Grab-catches to retro-fit to existing ISC Trolleys, please let us know the serial numbers of your Trolleys.

Parachute Harnesses are only compatible with the RP076 ZipSpeed-L Trolley and must be used together with the Stabiliser Bar mounting Kit. For connection of the mounting kit to the harness, we recommend the use of one KH212 Steel HMS Karabiner and two KL311 Steel Oval Karabiners. Harnesses are available in five sizes (S to XXL).

Superman Harnesses are only compatible with the RP076 ZipSpeed-L Trolley and should be attached using 3x KH212TL Karabiners.

## RP074 Zippey Trolley

### Compatible Accessories

Anti-rollback Cam (ARC)  
Grab-catch Hook  
HAN074 Handle Bar

## RP075 Zipspeed Trolley

RP075A 13mm (1/2") Wire

RP075B 16mm (5/8") Wire

RP075G 20mm (3/4") Wire

### Compatible Accessories

Anti-rollback Cam (ARC)  
Grab-catch Hook

## RP076 Zipspeed Trolley

RP076A 13mm (1/2") Wire

RP076B 16mm (5/8") Wire

RP076G 20mm (3/4") Wire

### Compatible Accessories

Anti-rollback Cam (ARC)  
Grab-catch Hook  
Parachute Harness  
Superman Harness  
Stabiliser Bar (req. with Parachute Harness)

## ARC074 Zippey ARC Cam

Weight 59g (2oz)

Max. Cable 12mm - 13mm (1/2")

Versions Available 12mm & 13mm

## ARC075 Zipspeed ARC Cam

Weight 67g - 74g (2.5oz)

Max. Cable 12mm - 16mm (1/2" - 5/8")

Versions Available 12mm, 13mm, 16mm

## ARC076 Zipspeed ARC Cam

Weight 79g - 100g (2.5oz - 3.5oz)

Max. Cable 12mm - 20mm (1/2" - 3/4")

Versions Available 12mm, 13mm, 16mm, 18mm, 19mm, 20mm





# SMARTSNAP DEVICE

SmartSnap™ is a self-belay system which allows the user to traverse all of the individual elements of a **course** without ever being able to detach from the line. SmartSnap is simple to use and therefore doesn't require in depth user training; it is lightweight and is therefore perfectly suitable for children to use. The SmartSnap has been designed so that it can easily be **retro-fitted** to an existing course.

The SmartSnap has two locking gates which are controlled by a mechanism which only allows one gate to open at any one time. Each course user wears a SmartSnap device, attached to their harness by a **short lanyard**.

At the beginning of the course, the supervisor attaches the **blue gate** of the SmartSnap to the wire (Fig. 1) and locks the gate, using the **wire-mounted key** (Fig. 2). The user then travels to the next changeover point, where they clip the **red gate** on to the **Ring Key lanyard** (Fig. 3). The user then inserts the Pin of the **Ring Key** into a hole (Fig. 4). This action simultaneously locks the red gate & unlocks the blue gate, releasing the user from the previous element, leaving them **safely attached** to the next element (Fig. 5).

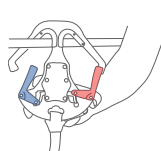

Fig. 1

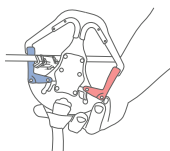

Fig. 2

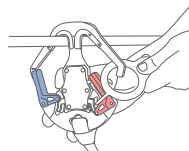

Fig. 3

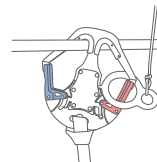

Fig. 4

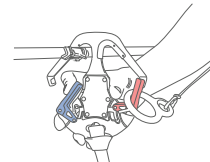

Fig. 5



**KY004A** Ring Key (Stainless Steel)  
**Weight** 130g (5oz)  
**MBS** 25kN (5620lbf)

**RP420** Smartsnap™  
**Weight** 330g (12oz)  
**MBS** 25kN (5620lbf)



**KY005A** Wire Key (For 13mm (1/2") Wire)  
**Weight** 36g (1oz)  
**MBS** N/A

**KY005B** Wire Key (For 10mm (3/8") Wire)  
**Weight** 36g (1oz)  
**MBS** N/A



# ALF CLIMB ASSIST SYSTEM

The ALF™ Climb Assist Pulley uses a uniquely designed locking system, which combines a speed sensitive inertia locking brake system, with a grooved pulley wheel. At low speed (during normal use), the rope runs freely through the pulley. In the event of a fall, the rope speed increases causing the brake to lock to promptly **arrest** the fall. Fall distances are extremely short, so in most cases the fallen user can regain their grip on the structure and resume the climb, **without** the need for assistance/instruction.

The ALF Pulley is a two-way locking device which can be rigged in a continuous loop system with **Alpine Butterfly** attachment loops at opposing ends of the system. This means that at the end of each climb/descent, there is always an attachment loop present, allowing the next user to immediately commence their climb/descent

The ALF Climb Assist Pulley was developed for users in the **Challenge Course Industry**, who needed a simple mechanical method of protecting multiple climbers en route around a ropes course. The ALF provides a simple, cost effective solution, which utilises Teufelberger Patron (EN1891) low stretch 11mm (7/16") rope. The continuous loop system can be quickly and easily rigged, by a competent person.

We recommend the use of the ISC RP066B1 **Large Single Prussik** (with Bearings), to help to maintain the optimum level of friction in this system. Pulleys sold separately.

**RP430** ALF™ Climb Assist Pulley  
**Weight** 1.2kg (2.7lb)  
**WLL** 140kg (310lb)

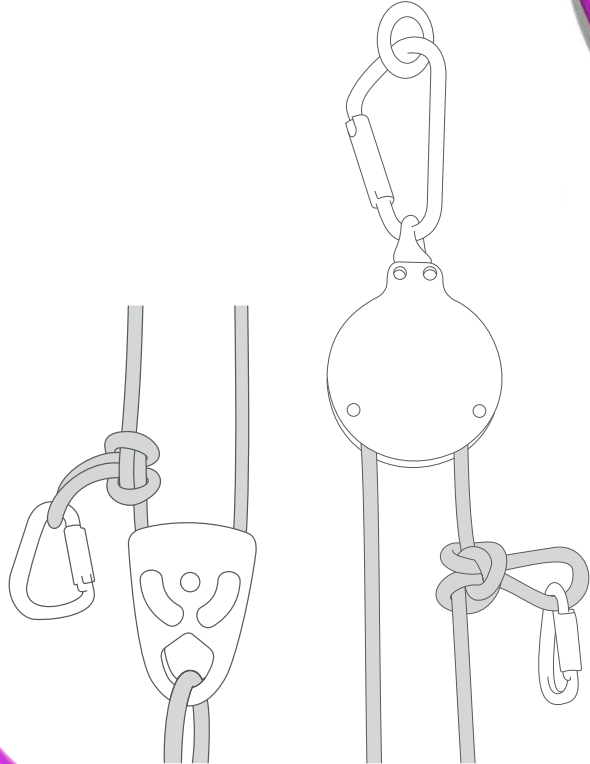

**WLL 140kg (330lb)**

\*ISC maintains regular testing of this device, with Teufelberger Patron Rope, in order to ensure consistency of compatibility. We therefore recommend the use of Teufelberger Patron rope. Other EN1891 ropes may be used at the user's discretion, however ISC does not undertake compatibility testing on any other ropes and cannot guarantee compatibility.

# RESCUE KITS & ACCESSORIES

Whenever **fall arrest systems** are used and a fall hazard exists, it is necessary to plan in advance, for the effective rescue of persons who have experienced a fall event.

ISC **Rescue kits** provide a series of pre-rigged 'off the shelf' solutions, to suit a range of raise/lower pick-off, and short lift-long lower rescues.

**Rescue kits** are available with a 15m Height of Lift (**HOL**), but other HOL lengths are available on request.



## Standard RK050A-015 15m HOL Kit includes:

- RP431 RALF Pulley x1
- RP064 Double Pulley x2
- 11mm LSK Rope (90m)
- KH221SS Karabiner x2
- Webbing Anchor Sling
- Rope bag
- Optional Heavy-duty Rescue Pole

### Applications:

Pick-off Rescue, Short Lift-Long Lower Rescue, Raise Rescue, Confined Space Raise/Lower Rescue, Horizontal Hauls and 2-Person Assisted Rescue.

### Suitable Accessories:

- RP209N Rescue Ropegrab Pip-pin
- RP210/ RP220 Professional Hand Ascender (left or right).



Our range of **Snaphooks** includes standard or fall-indicating **Swivel-eye** versions. We offer standard **double-action** mechanisms, or our unique **triple-action** mechanism, for extra security. Aluminium, steel and stainless steel models available.



The RP029 **Shear Reduction Pulley** wheel does not rotate, thus giving maximum friction. The **increased friction** makes this pulley ideal for increased control when used in **lowering applications**, such as top roping in Climbing Walls/Gyms and Ropes Courses.

## RK040A-015 Kit includes:

- HB165 165m HaulerBiner
- RP880 D4 Work/Rescue Descender
- 11mm LSK Rope (15m or 30m HOL options, as standard)
- KH204SS Karabiner x1
- Webbing Anchor Sling
- Lightweight rescue pole & rope bag

### Applications:

Short-lift, long lower rescue situations—single person rescue load.



We manufacture a very wide range of **Prussik** and **Eiger Pulleys** to suit 13 - 19mm (1/2" - 3/4") rope and with MBS ratings of up to **70kN** (15736lbf). All **Pulleys** are fitted with tamper-proof rivets. Our **Prussik Pulleys** are available with a choice of **Bushings** or **Bearings**.

ISC **Performance Karabiners** are forged for best build quality and feature a '**Blind**' nose, which improves performance & eliminates snagging. ISC **Aluminium Karabiners** are of sleek ergonomic design, with a high strength to weight ratio.



**International Safety Components Ltd.**

Unit 1, Plot 2  
Llandygai Industrial Estate  
Bangor  
Gwynedd  
LL57 4YH  
United Kingdom

+44 (0) 1248 363 110

[sales@iscwales.com](mailto:sales@iscwales.com)  
[www.iscwales.com](http://www.iscwales.com)



**Stay up to date with ISC e-mail alerts!**

Scan the QR Code with your Smartphone to register for ISC e-mail Alerts. We will email you from time to time with news of new products, product updates and other news features which are relevant to your chosen industry.